

YAMAHA KT100S SERIES ENGINES

TECHNICAL SPECIFICATIONS

Preamble:

The following are the Technical Specifications for the Yamaha KT100SE and Yamaha KT100SD engines, as approved by the Australian Karting Association.

These engine are approved for use in the following classes.

- Junior Clubman
- Clubman Light
- Clubman Heavy
- Clubman Super Heavy
- Over 40's Clubman

Unless otherwise specified, the engines must be original in all their components according to the Yamaha KT100S drawings.

Any removal, addition or polishing of material is strictly forbidden.

Sandblasting, glass bead blasting, peening, acid etching, spark eroding and/or any other method of metal removal or displacement is not allowed.

ANY ALTERATIONS / MODIFICATIONS ARE STRICTLY PROHIBITED EXCEPT AS SPECIFICALLY AUTHORISED WITHIN THESE SPECIFICATIONS.

IF THESE SPECIFICATIONS DO NOT SAY YOU CAN MAKE A MODIFICATION, THEN YOU CANNOT.

KTS 1.01 Engine Displacement:

The maximum piston diameter and stroke length are:

Piston	Stroke
53.00mm	46.13mm

KTS 1.02 Cylinder Machining:

All machined surfaces may be re-machined as long as engine is within any other specifications within these rules.

KTS 1.03 Cylinder Ports:

1. All ports are to be in "as cast" condition except at the junction of the cast iron sleeve and aluminium jacket. Grinding is permitted to remove casting irregularities at the junction ONLY. No chamfer on port edges is permitted.

This Rule DOES NOT allow grinding or alternations by any method to:

- (a) change the roof angle;
 - (b) alter port height, width or angle;
 - (c) change the shape or size of the passages from the cylinder base to the port;
 - (d) match the cases to the port passages.
2. Due to manufacturing procedures, it is possible that some engines may have slightly "broken" port edges. When this exists it is uniform on all port edges (tops, bottoms and sides) of all ports in the cylinder. The intersection of the port edges and the cylinder wall must still be within the technical measurements. As the bore size increases the amount of "break" diminishes. If the cylinder bore is 52.45mm or larger, no "broken" edges are allowed.
 3. Due to manufacturing procedures, some cylinders have some minor grinding on the transfer divider bridges and some evidence of casting irregularities removed in transfer passages, this includes the transfer area in the crankcase.

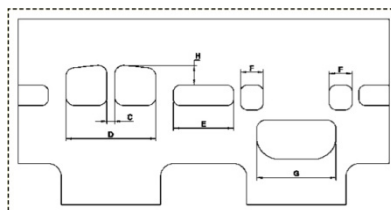

COD	DIMENSION	COD	DIMENSION
D	39.60mm max	E	26.15mm max
C	3.40mm min	F	13.13mm max
G	34.80mm max	H	9.50mm min

KTS 1.04 Cylinder Head:

1. Must be an original Yamaha casting.
2. The welding and re-machining of the combustion area, gasket face is allowable. Additions/repairs must be permanent and non-adjustable.
3. The combustion chamber style is required to have a squish band and chamber which are visually concentric to the spark plug.
4. The combustion chamber volume shall be a minimum of 11cc. (Ref rule 26.01)
5. The combustion chamber/squish area shall not protrude beyond the gasket sealing face of the cylinder head.
6. The spark plug thread may be repaired and shall retain its original position in relation to crankshaft axis. Helicoils and similar are permitted.
7. Maximum distance from sealing surface of spark plug to combustion chamber sealing face shall be 32.5mm.
8. Repairs to the spark plug sealing face must be by addition of weld material only and re-machining to a flat surface.
9. The head gasket must be retained.

KTS 1.05 Fin Dampeners:

To effectively reduce noise, it is compulsory that the Yamaha KT100S Series Engine be fitted with:

- (a) A minimum of four rows of fin dampeners on the cylinder. Fin dampeners must make contact with all fins.
- (b) Two rows of fin dampeners are to be fitted to the cylinder head. Fin dampeners must make contact with all fins.

KTS 1.06 Piston:

Piston must be approved and stock appearing.

AKA approved/registered pistons are YAMAHA, KSI, KSI MK 11, JDP/Vertex and ARC (forged and cast) and Strike.

Bottom of piston should be 90 degrees to sides. It is permissible to notch the piston to allow the removal of circlip. The piston skirt length may be machined, providing it conforms to the current specifications as laid down in these Rules.

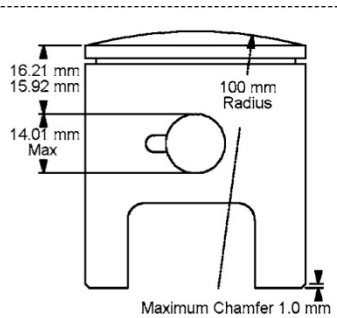

DIAGRAM IS FOR DIMENSIONAL REFERENCE ONLY

Note: Skirt length must be equal distance on both sides

KTS 1.07 Connecting Rod:

Can be either of the following and must be stock:

- (a) Yamaha or KSI.
- (b) Minimum/Maximum rod length, centre to centre 99.87mm – 100.13mm.
- (c) Conrod alignment may be either top or bottom.
- (d) Bearings and spacers are non-tech items
- (e) 50W –11651-00 Yamaha “J” rod is not eligible

KTS 1.08 Crankshaft:

Legal crankshafts are Yamaha or KSI

- (a) Outside diameter measurement: 86.60mm min., 87.25mm max.
- (b) Crank Pin to be standard hollow pin.
- (c) It is permissible to recondition the crankshaft main shaft by plating
- (d) It is permissible to repair the drive side crankshaft end, where the threaded section has broken off by drilling and tapping the centre of the crank to accept an M6 or M8 screw.

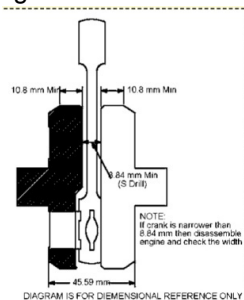

DIAGRAM IS FOR DIMENSIONAL REFERENCE ONLY

KTS 1.09 Crankcase:

The crankcase ports will remain as cast. The minimum chordal distance measured with a vernier caliper across the widest section of the transfer ports shall be 97.5mm minimum. (Refer diagram below). All machined surfaces may be re-machined as long as engine is within any other specifications within the rules. It is permissible to repair crankcase main bearing recesses by welding or with metal inserts.

It is permissible to use ARC electric start crankcase & crankshaft on Yamaha KT100SE & KT100SD if the clutch, starter motor, starter motor battery and electrical system is fitted.

NOTE: Existing crankcases that are narrow may be spaced with a thicker gasket.

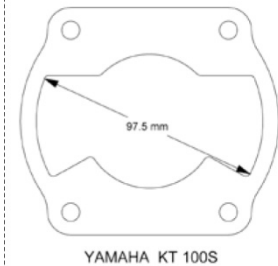

DIAGRAM IS FOR DIMENSIONAL REFERENCE ONLY

KTS 1.10 Ignition:

a) Ignition must be that supplied by the original engine manufacturer which is approved by the AKA. Any optional unit must be approved and registered with the AKA for this class.

The use of the following AKA approved TCI module is permissible on KT100SE and KT100SD engines only:
YAMAHA, VICTA, ATOM, DELTA/WEI SHIEH, PRD, PRD with coil.

No modifications or repairs to any of the listed AKA approved modules is permitted.

The fitting of a PRD ignition coils and a PRD ignition rotors (flywheel) is permissible (this includes the Oppama ignition system) on KT100SE and KT100SD engines only.

- b) Ignition timing may be adjusted by the removal of the locating key or part thereof on KT100SE and KT100SD engines only.
- c) All engines must rotate in a clockwise direction when viewed from the drive side.
- d) Ignition/rotor cover optional – compulsory for the SEC engine
- e) It is permissible to repair/replace the connector on the TCI module and mating wiring.

KTS 1.11 Carburettor:

Must be Walbro WB series conforming to dimensions as per diagram.

(Note – WB 24 is not eligible)

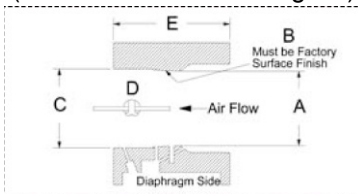

DIAGRAM IS FOR DIMENSIONAL REFERENCE ONLY

- (a) It is permissible to machine the Walbro carburettor body to
- conform to dimension E
 - conform to dimension C
 - accept an O ring for the low speed jet and throttle shaft.
- b) A threaded butterfly screw must be retained, countersunk screws are not permitted. Butterfly and shaft must be as manufactured.
- c) It is permissible to repair the inlet seat and throttle shaft bore in the Walbro carburettor. Carburettor bore may not be sleeved.
- d) It is permissible to enlarge only existing fuel / air holes, but they may not be deleted or relocated. The holes must be the same shape as originals when viewed externally.
- e) All air must pass through the carburettor throat.
- f) Measurement code:
- As cast MAX Venturi diameter 24.13mm
 - As cast (area will extend from the front of the carburetor to the progression discharge jet which must have all or portion of this jet in the cast area.)
 - MAX downstream diameter 25.7mm
 - Butterfly shaft must be located at the bore centre.
 - MIN carburettor body length of 37.5mm

No internal inspection required, ie covers will not be removed and only external measurements and visual inspection taken.

KTS 1.12 Pressurised Fuel Systems:

Fuel pump or pressurised fuel systems are forbidden. Squeeze type pump between fuel tank and carburettor is permitted.

KTS 1.13 Phenolic Spacer:

Hole size 26.42mm max.

KTS 1.14 Aluminium Carburettor Mount Plate:

Hole size 26.29mm max.

KTS 1.15 Inlet Tract Length:

The inlet tract has a minimum dimension of 65mm and is to be measured from the aluminium carburettor adaptor outer face to the skirt of piston.

KTS 1.16 External Modifications:

External modifications, which do not in any way affect a performance gain, are legal.

KTS 1.17 Internal Parts:

All internal parts must be finished as per Yamaha Factory specifications.

KTS 1.18 Internal Additions:

No additional material may be added except in the case of engine repairs and shall only restore engine or components to original specifications. The cylinder may NOT be repaired in any of the port or passage as cast areas.

- (a) The use of thermal barrier coatings / ceramic coatings on or in the engine / engine components and on or in exhaust components is prohibited.
- (b) The use of anti friction coatings on or in the engine / engine components is prohibited.

KTS 1.19 Legal Additions:

Legal additions shall be limited to the following: Chain guard, motor mount, direct drive gear, extension of carburettor jet needles, carburettor return springs, third bearing and adapter (for ARC clutch only), temperature gauge and tachometer.

KTS 1.20 Non-tech Items:

- (a) Non-tech items are gaskets, seals, big end roller/cage, little end spacers, rings, washers, cages, fasteners, fulcrum spring (carburetor meter levering spring), spark plug and spark plug lead and cap, gudgeon pins, main bearings, coolant sealing "O" rings, engine sprocket and key.
 1. Unless specified, non-tech items are to be of the same type and style as the original. No alteration from the original manufacturer's specifications is permitted to fit a non-tech item
 2. Head gasket/s must be retained
 3. Cylinder base baskets are dimensionally free
 4. Carburettor base and phenolic spacer gaskets are dimensionally free
 5. Only crankcase half gasket may be formed from liquid gasket compounds
 6. Cylinder base adjusting shims/spacers may be of any material and must be of uniform thickness.
 7. Spark plugs must have a maximum engagement length of 20mm without the washer.

8. A direct drive sprocket (complete) cannot weigh more than 100 gms.
9. A direct drive sprocket retaining nut cannot be made from a hex material greater than 19mm AF.
10. Pull start and electric start systems are non-tech.

KTS 1.21 Exhaust Header Pipe:

This item is not restricted to the original Manufacturer but must conform to the type (style) and of the original header pipe. Inside diameter must be parallel.

Minimum Length permitted 120mm (as per diagram below)

Maximum inside diameter of 36mm.

Minimum diameter 34mm. Refer diagram

It is permissible to stiffen the exhaust flange to the extent shown in the drawing.

The maximum length from the engine side face of the flange to the end of any stiffening is 20mm

Any stiffening must not interfere with the fitting of exhaust seals.

Modifications to fit an exhaust probe are permissible. A maximum of one (1) Exhaust probe/fitting is permitted. The maximum diameter of the probe is 6mm. Maximum length of exhaust probe is 25mm

Exhaust header studs must remain in their original position.

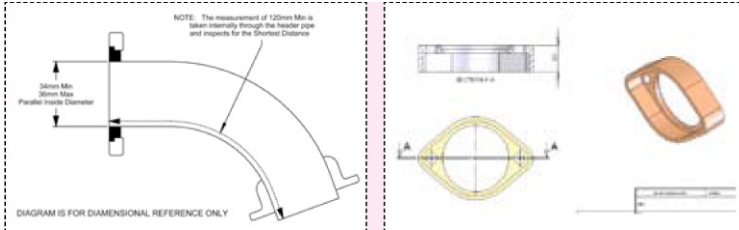

KTS 1.22 Exhaust System:

1. Must be such as to carry the exhaust gases away from and to the rear of the driver.
2. Exhaust gases must all pass through the exhaust header pipe and the muffler and silencer (if mandatory) at all times.
3. Mufflers must conform to Rule 24.2 of the AKA manual with respect to noise level. (Supplementary Regulations may allow for a lesser noise level.)
4. The open end must point in such a way so that it does not present a hazard to other drivers.
5. Muffler must be securely fastened with springs to a mounting bracket cradle and to the header pipe of the engine. A secondary fastening system, comprising a multi-strand wire (as used in throttle cables) to be secured through a fixing lug or a similar attachment (e.g. hose clamp) on the muffler and fixed to the chassis, excluding rear bumper bar to prevent the exhaust system detaching from the kart.
6. It is permissible to use, externally, heat proof wrapping between the springs and exhaust cradle and the springs and flex.

KTJ 1.23 Exhaust Muffler: AKA 39 CONTROLLED EXHAUST MUFFLER

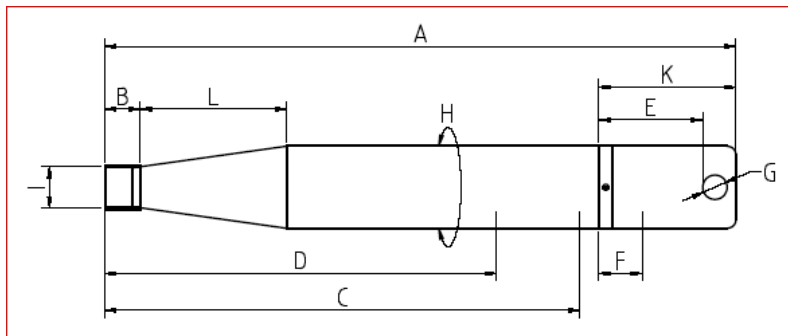

Reference	Description	AKA 39
A	overall length	675mm
B	internal tail pipe length	38mm
C	tail pipe to baffle length	512mm
D	tail pipe to deflector length	422mm
E	exhaust outlet hole position	112mm
F	end cap to baffle	47mm
G	maximum diameter outlet hole	26.3mm max
H	circumference	280mm
I	"internal diameter" tail pipe inlet	46.0 +/- 1mm
J (not shown)	maximum diameter of internal baffle plate hole	N/A
K	end cap length	148mm
L	inlet pipe to first weld (cone length)	158mm

Dimensional References:

Unless specified as a maximum measurement, the following dimensions are subject to Rule 26.02 General Tolerances, in the AKA Manual.

- (a) No device capable of being moved whilst racing is permissible in or on the exhaust.
- (b) The only permissible exhaust muffler for classes using the KT100S Series Engine is the control pipe AKA 39 manufactured by Powermac. The AKA 39 exhaust pipe carries precise dimension specifications that allow confidence in equality of performance for all competitors using the KT100S series engine.
- (c) Any measurement related to weld at either end of the cone will be taken to the centre line of the weld.
- (d) All other dimensions not specified carry stringent technical specifications. Any attempt to alter these dimensions will deem the unit illegal.
- (e) Any accidental damage (when all gasses still pass through the exhaust system as per rule 25.09.2) will

not incur a technical breach of these rules.

- (f) It is permissible to weld a fixing lug to the external surface of the AKA 39 body.
- (g) With the exception of repair to fixing points, any attempt to repair damage by cutting, welding or fabrication will automatically remove eligibility of the exhaust unit.
- (h) The exhaust header pipe and muffler can be joined by a pipe or flexible tube with a constant wall thickness, ends must be within 5 degrees of perpendicular to the centreline of the tube, min 36mm ID max 46.5mm OD these being an absolute size all TOLERANCES included. Exhaust spacers are allowed and must be of material equal to the permitted size of the joining exhaust flex or pipe, be of parallel bore, and within 5 degrees of perpendicular.
- (i) An "R" end-cap for the AKA39 control pipe is not permitted to be fitted to an AKA14 "J" body and an "R" end-cap for the AKA14 control pipe cannot be fitted to an AKA39 "S" body.

For information and clarification of Exhaust Bodies and End Caps:

- An AKA39 complete exhaust unit is identified by an alphanumeric stamp on the main body at the inlet end, and on the end-cap. (Eg: S00123456)
- An AKA39 end-cap replacement is identified by an alphanumeric beginning with R on the end-cap (: Eg R123456)
- An AKA14 complete exhaust unit is also identified by an alphanumeric stamp on the main body at the inlet end, and on the end-cap. (Eg: S00123456)
- An AKA14 end-cap replacement is identified by an alphanumeric beginning with R on the end-cap (: Eg R123456)
- A pre alpha numerical AKA14 complete exhaust pipe is identified by the AKA14 stamp on the main body of the pipe and the end-cap and is eligible for competition.

Competitors are requested to check their exhaust pipes for compliance with the new regulation.

KTS 1.24 Clutch:

The only permissible clutches to be used with the Yamaha KT100S series engine are the following AKA registered clutches, as per rule 25.17 of the AKA Manual.

- Freeline SL AKA # 44 (short shaft) only
- Strike SSS AKA # 45 (short shaft) only
- Ital Red AKA # 55 (short shaft) only
- Tomar TD22 AKA # 56 (long shaft) only
- ARC (ARC electric start bottom end) only
- Strike SSS evolution AKA # 47 (Yamaha SEC engine) only
- KT100SEC 7yps AKA # 57 (Yamaha SEC engine) only
- Drive belt pulley AKA # 52 (SSS clutch) only
- Ital Red "S" Taperlock AKA #.55A (Short shaft) only
- Zedtec ZD1 Long shaft and short shaft